

AIRWIN®

P N E U M A T I C

www.airwinpneumatics.in

AP 22 Series ISO15552 Standard Cylinder



AP22

Ordering Code

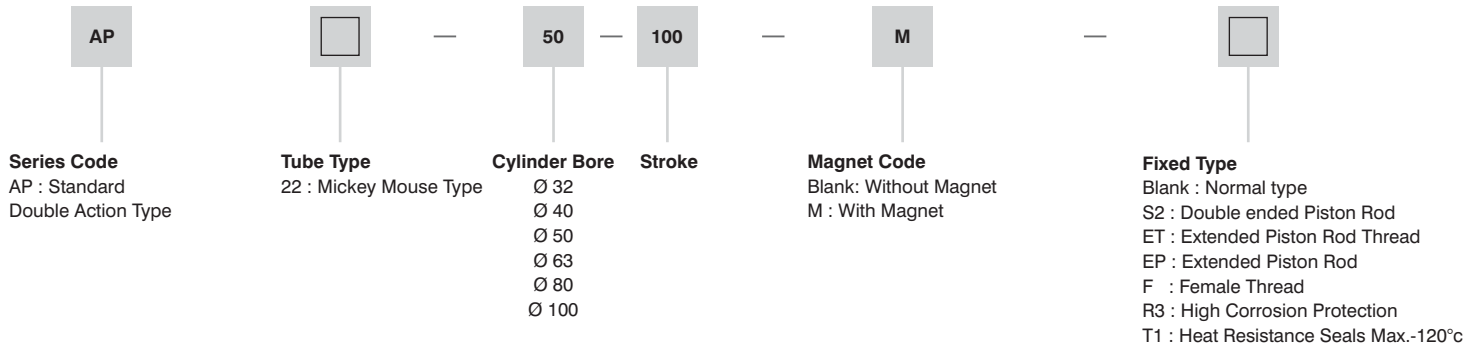

Specification

Bore(mm)	32	40	50	63	80	100	125
Motion Patten	Double Action						
Working Medium	Filtered Air						
Compression Pressure	1.5MPa						
Max. Operating Pressure	1.0MPa						
Min. Operating Pressure	0.2MPas						
Cushioning	Pneumatic cushioning						
Condition Temperature	-5°C to 70°C						
Operating Speed	50-800mm/s						
Port Size	G1/8"	G1/4"		G3/8"		G1/2"	
Stroke Range	10 - 2000 Above 800 stock guide must be used for better performance						

AP 22 Series ISO15552 Standard Cylinder

Overall Dimensions

Normal Type
AP22

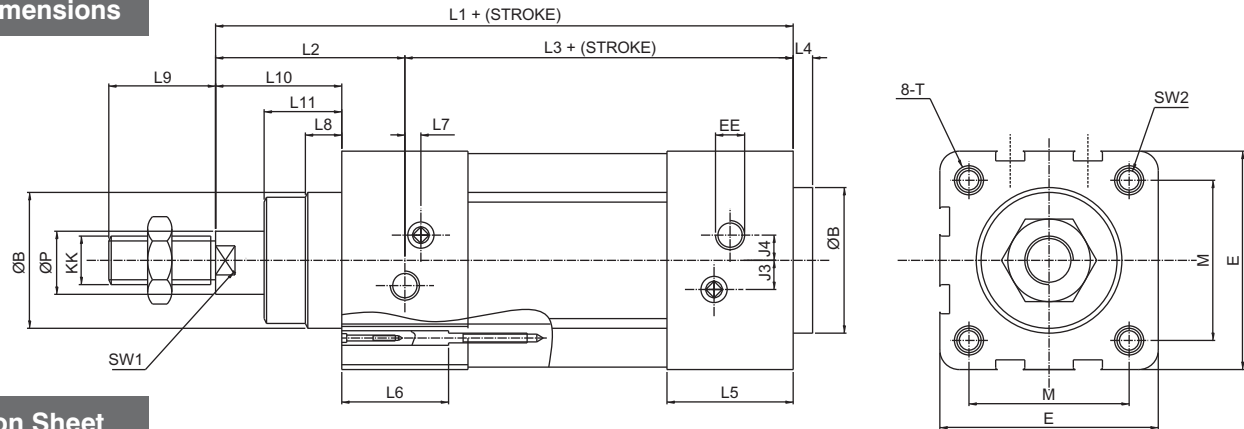

Dimension Sheet

Bore	KK	M	P	E	EE	B	T	J3	J4	SW1	SW2
32	M10 X 1.25	32.5	12	45	1/8	30	M6	6	5.2	10	6
40	M12 X 1.25	38	16	54	1/4	35	M6	8	6	13	6
50	M16 X 1.5	46.5	20	64	1/4	40	M8	10	8.5	17	8
63	M16 X 1.5	56.5	20	75	3/8	45	M8	12.4	10	17	8
80	M20 X 1.5	72	25	93	3/8	45	M10	12.5	8	22	10
100	M20 X 1.5	89	25	110	1/2	55	M10	11.8	10	22	10
125	M27 X 2	110	32	134	1/2	60	M12	13	8	28	12

Bore	L1	L2	L3	L4	L5	L6	L7	L8	L9	L10	L11
32	120	40	80	4	26	22	3.3	8	22	26	16
40	135	46	89	4	29.6	22	3.6	10	24	30	20
50	144	54	90	4	30	22	5.1	10	32	37	27
63	158	57	101	4	35.5	22	6.6	10	32	37	27
80	174	65	109	4	36	25	10.5	10	40	46	34.5
100	189	71	118	4	39	25	8	12.5	40	51	38
125	223	95	128	6	44.7	30	14	12.5	54	65	46

Overall Dimensions

Double Piston Rod Type
AP22 -- S2

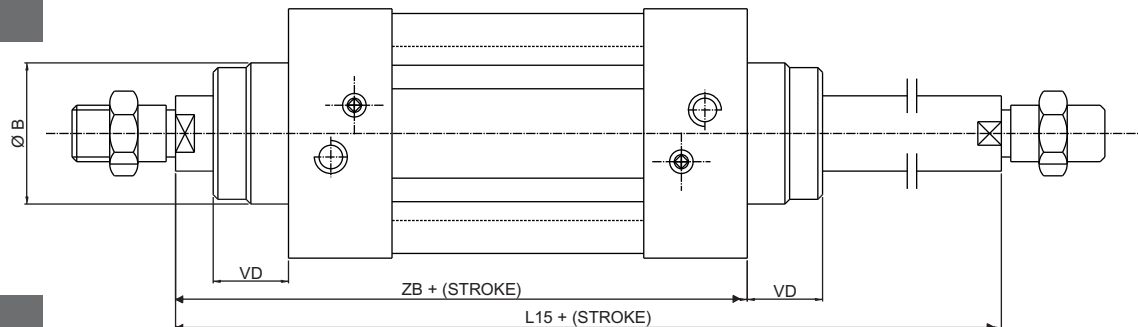

Dimension Sheet

Bore	32	40	50	63	80	100	125
B	30	35	40	45	45	55	60
L15	146	165	128	194	220	240	298
VD	16	20	27	27	34.7	38.2	46
ZB	120	135	144	158	174	189	223



www.airwinpneumatics.in

AIRWIN ENGINEERS

10, Ghanshyam Ind. Area, Virani Aghat, Off. Dhebar Road, Octroi Naka,
Rajkot-360004, Gujarat. **Mo.** 99799 00957, 99799 00956

Email :- info@airwinpneumatics.in, Airwinpneumatics@outlook.com

Web : www.airwinpneumatics.in